

PIANTA STRUTTURA PAVIMENTO

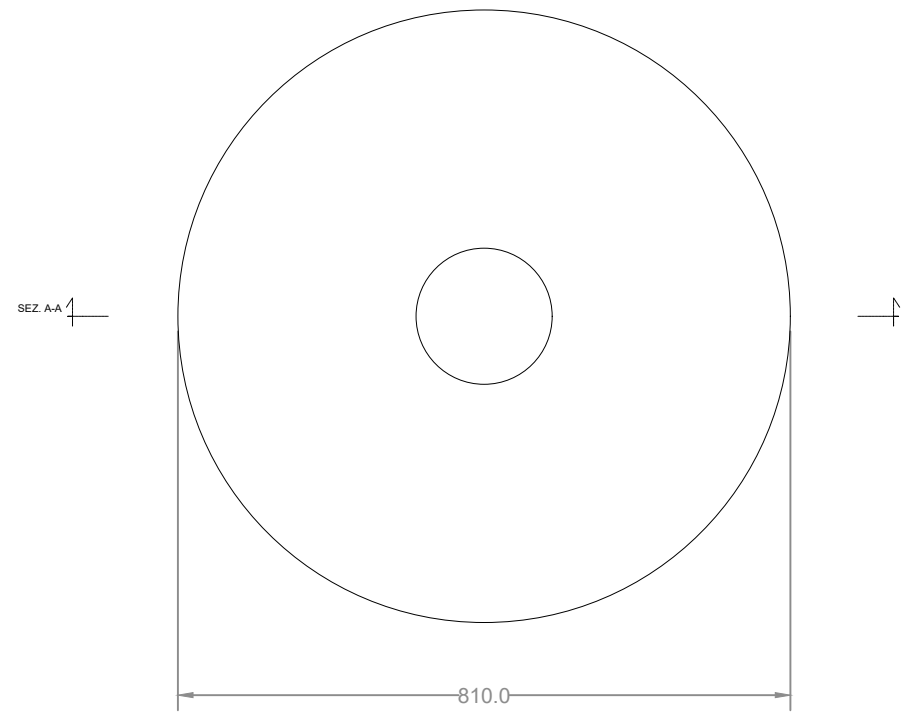

PIANTA COPERTURA

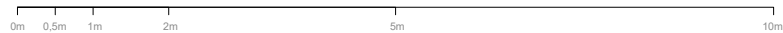

YURTA STANDARD 8m

CARATTERISTICHE:

Diametro - 8 m
 Area a terra - 50,26 mq
 Altezza max interna - 325 cm
 Altezza pareti - 180 cm
 Volume interno - 114,67 mc
 Circonferenza - 25,13 m



LA LEGGERA S.N.C.

PROGETTO

**YURTA
 modello standard - 8m**

DISEGNO E SCALA

**YURTA STANDARD
 scala 1:100**

DATA

08/08/2025

DISEGNO

Architetta Giulia De Oliveira

NUMERO

1/4

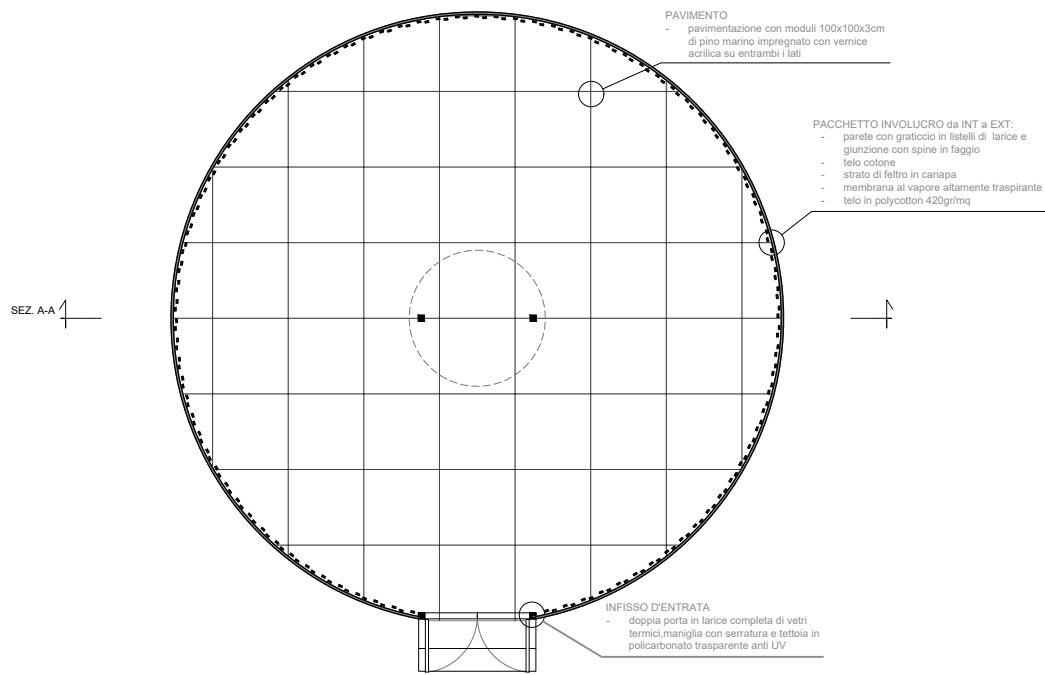

PIANTA STRUTTURA PAVIMENTO



LA LEGGERA S.N.C.

PROGETTO

YURTA
modello standard - 8m

DISEGNO E SCALA

YURTA STANDARD
scala 1:100

DATA

08/08/2025

DISEGNO

Architetta Giulia De Oliveira

NUMERO

2/4

SEZIONE A-A - ARCHITETTURA

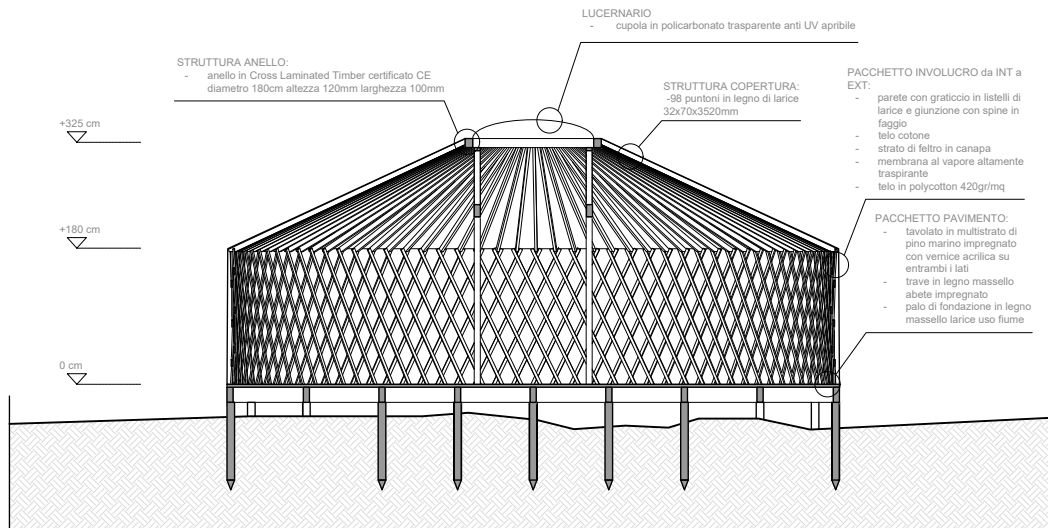

PROSPETTO - ARCHITETTURA

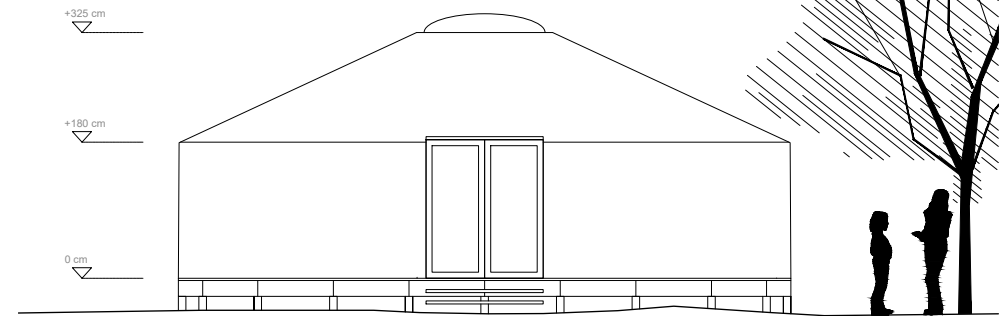

LA LEGGERA S.N.C.

PROGETTO

YURTA
modello standard -8m

DISEGNO E SCALA

YURTA STANDARD
scala 1:100

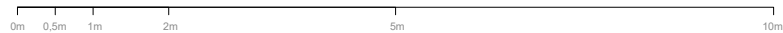

DATA

08/08/2025

DISEGNO

Architetta Giulia De Oliveira

NUMERO

3/4

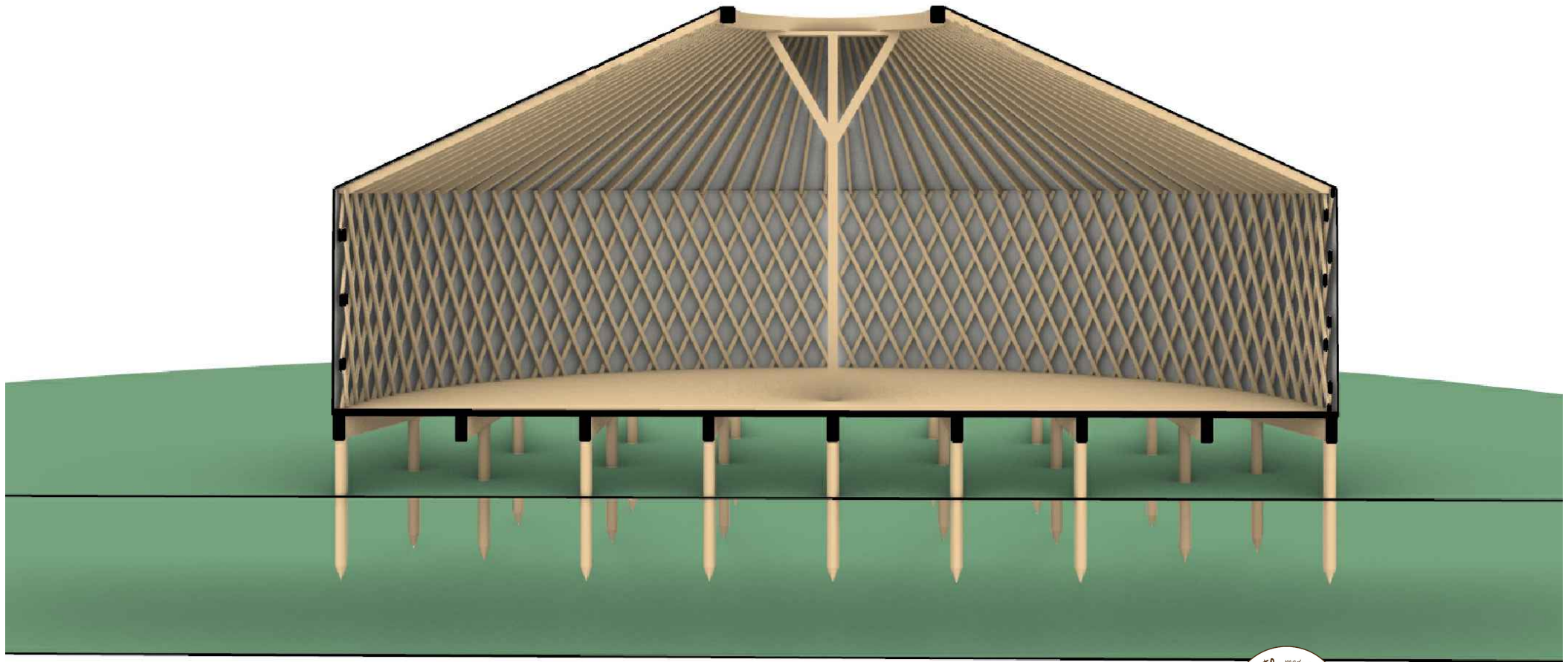

LA LEGGERA S.N.C.

PROGETTO

YURTA
modello standard - 8m

DISEGNO E SCALA

YURTA STANDARD
SEZIONE PROSPETTICA ILLUSTRATIVA

DATA
05/06/2025

DISEGNO
Architetta Giulia De Oliveira

NUMERO
4/4
