

PIANTA STRUTTURA PAVIMENTO

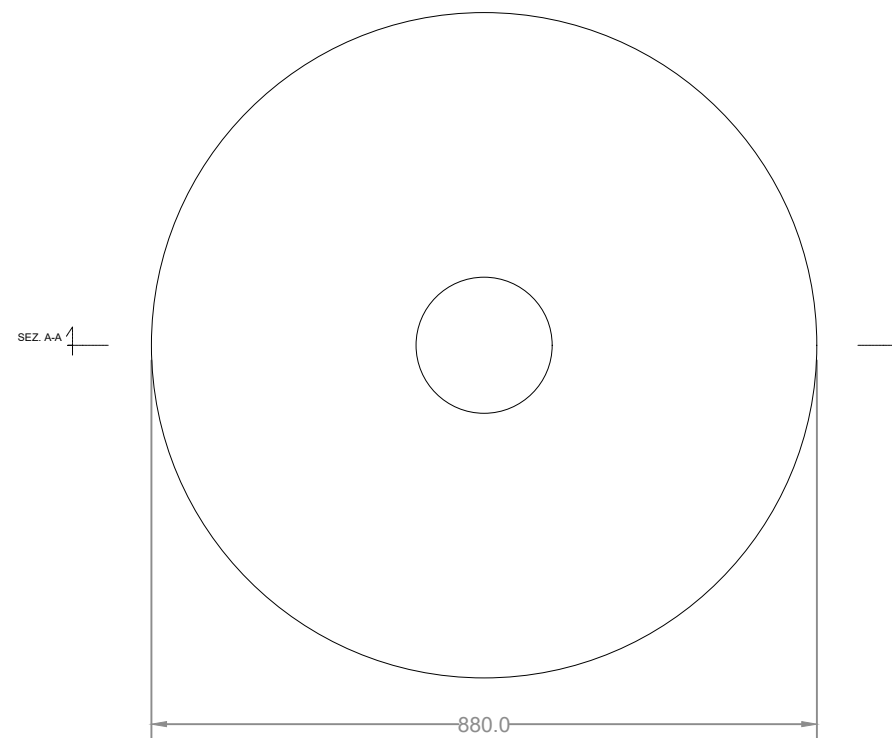

PIANTA COPERTURA



YURTA STANDARD 8,8m

CARATTERISTICHE:

Diametro - 880 cm
 Area a terra - 60,81 mq
 Altezza max interna - 336 cm
 Altezza pareti - 180 cm
 Volume interno - 141,02 mc
 Circonferenza - 27,64 m



LA LEGGERA S.N.C.

PROGETTO

**YURTA
 modello standard - 8,8m**

DISEGNO E SCALA

**YURTA STANDARD
 scala 1:100**

DATA
 03/04/2026

DISEGNO
 Architetta Giulia De Oliveira

NUMERO
 1/4

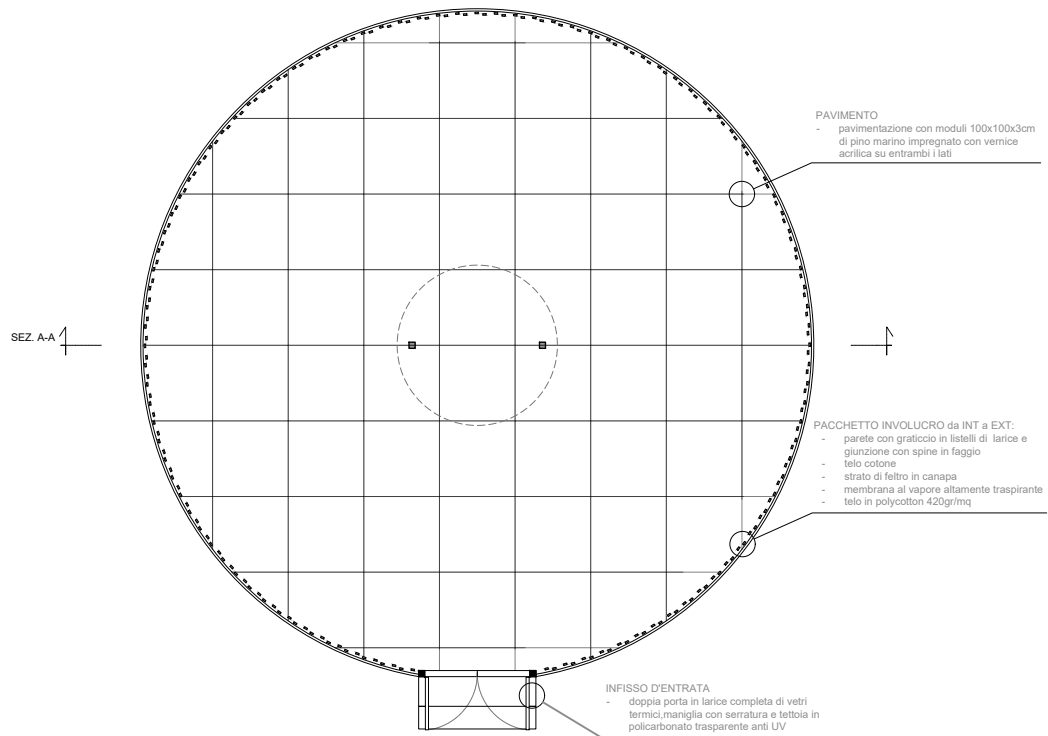

PIANTA STRUTTURA PAVIMENTO

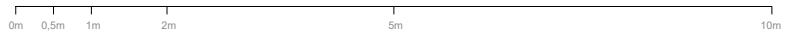

LA LEGGERA S.N.C.

PROGETTO

YURTA
modello standard - 8,8m

DISEGNO E SCALA

YURTA STANDARD
scala 1:100

DATA

03/04/2026

DISEGNO

Architetta Giulia De Oliveira

NUMERO

2/4

SEZIONE A-A - ARCHITETTURA

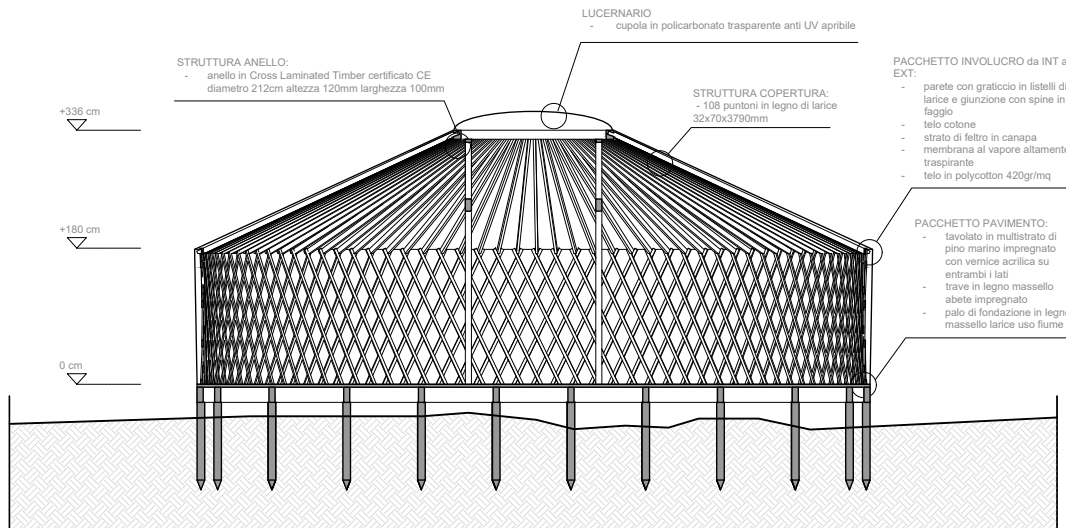

PROSPETTO - ARCHITETTURA

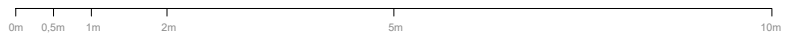
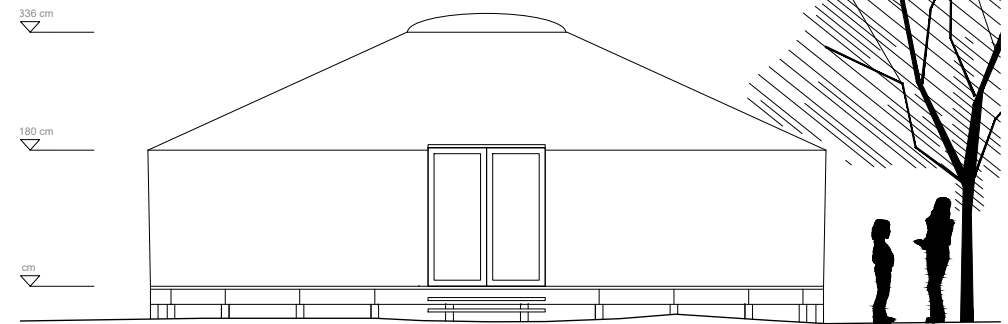

LA LEGGERA S.N.C.

PROGETTO

YURTA
modello standard - 8,8m

DISEGNO E SCALA

YURTA STANDARD
scala 1:100

DATA

03/04/2026

DISEGNO

Architetta Giulia De Oliveira

NUMERO

3/4

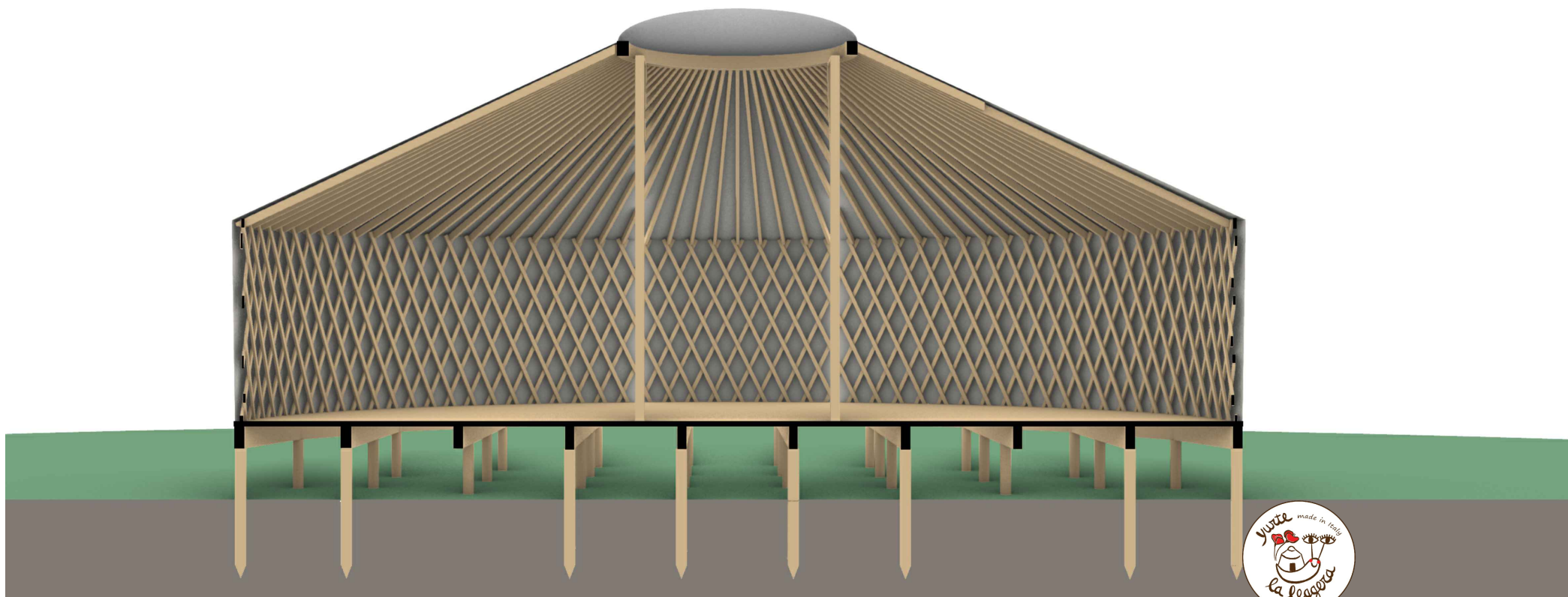

LA LEGGERA S.N.C.

PROGETTO

YURTA
modello standard - 8,8m

DISEGNO E SCALA

YURTA STANDARD
SEZIONE PROSPETTICA ILLUSTRATIVA

DATA
03/04/2026

DISEGNO
Architetta Giulia De Oliveira

NUMERO
4/4
